

ROOLF

OUTDOOR LIVING

the
silky
collection





the silky collection

Our desire to strive for the ideal world, is a never ending story. We continue to search for more, for better, to bring you the best... because you deserve it!

With the Silky collection, in addition to the goals already achieved, we have focused on softness. Our search has brought us to the “chenille” yarn. This type of yarn owes its name to its shape. It takes the shape of caterpillars such as the Pine processionary. Chenille is the French name for caterpillar.

Many months it took us to develop the perfect indoor/outdoor chenille with success.

To highlight this noble yarn even more, we have also chosen to finish the seats with a sophisticated edging.

Come with us and enjoy this journey through our catalog that takes us from our home over the mountains to sunny beaches. My home is where my Roolf-Living is.



the
corner
seat



the
corner
seat



The Corner Seat
Gold



The Corner Seat
Terracotta



The Corner Seat
Lilac



The Corner Seat
Grey



The Corner Seat
Anthracite



The Corner Seat
Beige

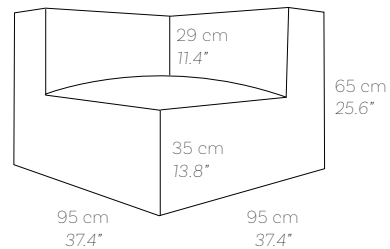

20 kg
44.1 lbs



the
club
seat

the club seat



The Club Seat
Gold



The Club Seat
Terracotta



The Club Seat
Lilac



The Club Seat
Grey



The Club Seat
Anthracite



The Club Seat
Beige

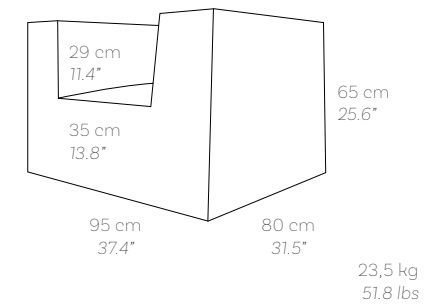

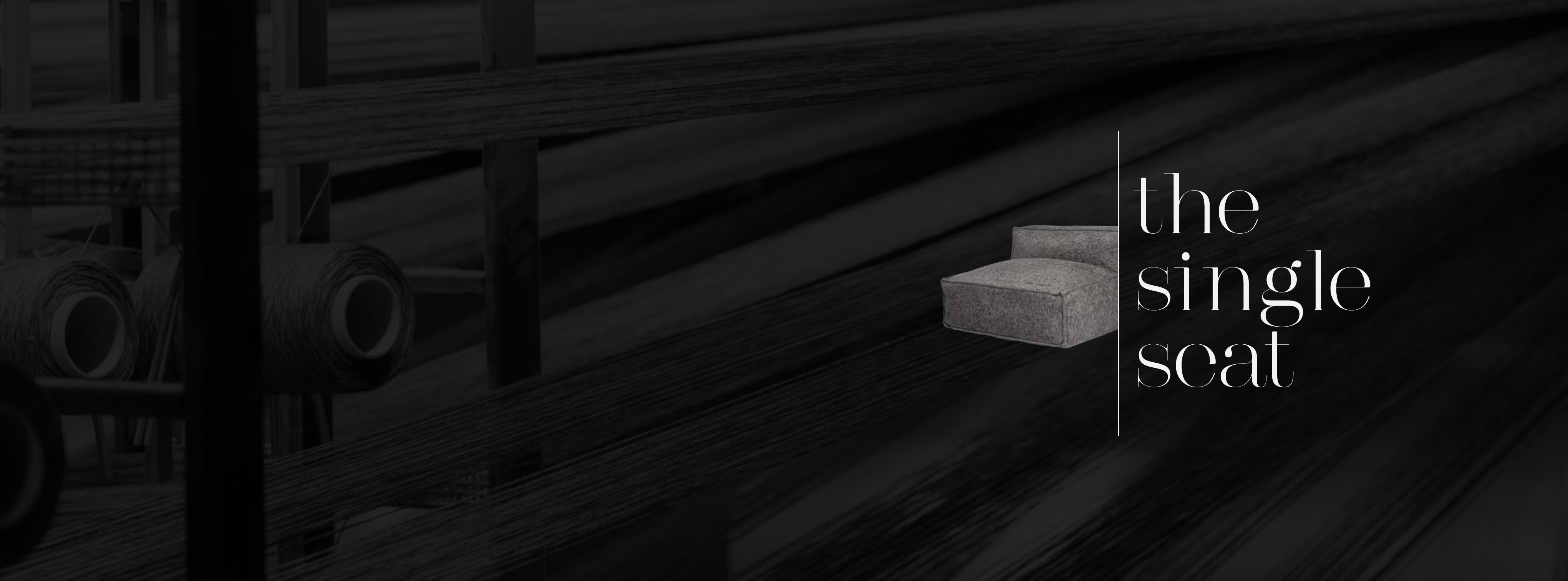

the
single
seat

the
single
seat

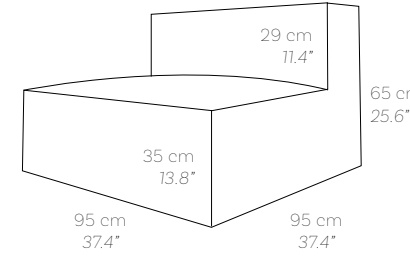

20,5 Kg
45.2 lbs



The Single Seat
Gold



The Single Seat
Terracotta



The Single Seat
Lilac



The Single Seat
Grey



The Single Seat
Anthracite



The Single Seat
Beige





the
long
chair

the long chair



The Long Chair
Gold



The Long Chair
Terracotta



The Long Chair
Lilac



The Long Chair
Grey



The Long Chair
Anthracite



The Long Chair
Beige

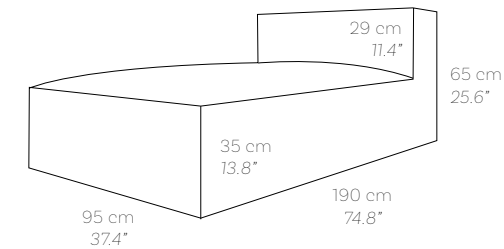

33 kg
72.8 lbs

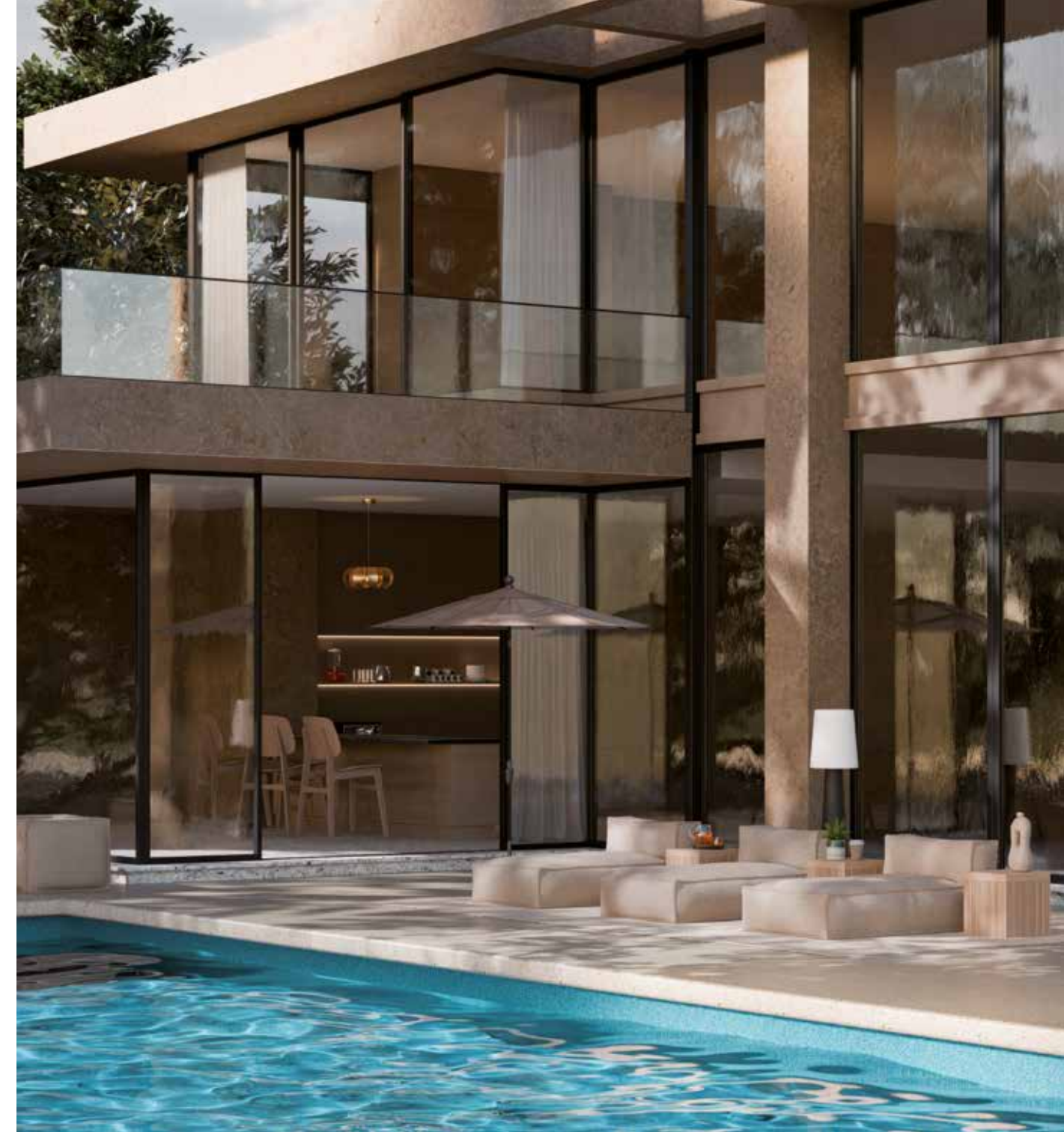



the
square
pouf



the square pouf

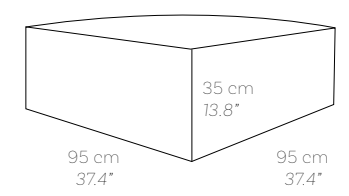

14,9 kg
32,8 lbs



The Square Pouf
Gold



The Square Pouf
Terracotta



The Square Pouf
Lilac



The Square Pouf
Grey



The Square Pouf
Anthracite



The Square Pouf
Beige





the
round
pouf



the
round
pouf

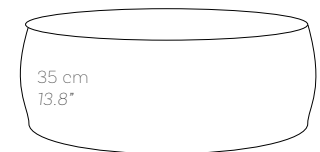

12 kg
26.5 lbs

95 cm
37.4"



The Round Pouf
Gold



The Round Pouf
Terracotta



The Round Pouf
Lilac



The Round Pouf
Grey



The Round Pouf
Anthracite



The Round Pouf
Beige





Whether you are craving your favourite drink, a good book or a tasty snack, the Silky coffee table allows you to have everything within easy reach, not only making your pouf more functional but also giving it a sophisticated look.

The timeless design of this table harmonises perfectly with your Silky setting, turning any outdoor space into an oasis of elegance.

Choose teak and discover the perfect balance between elegance and functionality, transforming your outdoor space into an oasis of timeless luxury.

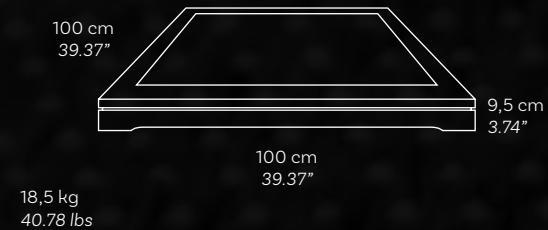

the silky coffee table

Discover the Silky Base: Increased Comfort, Refined Aesthetics

The benefits:

1. Increased Sitting Position:

Enjoy an enhanced seating experience with our Silky Base. Thanks to the base, the seat height is increased for more comfort and convenience. Now you can relax and enjoy your moments in the perfect position.

2. Aesthetic Added Value:

The Silky base combines aluminium with an anodised bronze finish for a timeless aesthetic. The four legs, deeper and streamlined, create a floating effect that gives your Silky pouf an airy look. Simple, yet sophisticated, the base adds a touch of elegance to your outdoor space.

3. Enhanced Protection:

Protect your seating from dirt and moisture by raising it off the ground with our Silky Base. With a clever design, we make sure your pouf remains safe and protected while you enjoy your outdoor space.

4. Practical Functionality:

With strategically placed holes for water drainage, our base offers practical solutions for all weather conditions. In addition, a small curb ensures your seat stays in place even during windy days.



the silky base

Wintering outside?

The Silky Collection from Roolf Living is made of 100% polyester and is perfect for outdoor use.

If you not only want to keep your garden furniture clean but also extend its lifespan, use our Silky protector. It offers simple but effective protection against wind and weather so that your garden furniture continues to shine year after year. You can use it for overwintering, but comes also in handy during our changeable in-between seasons.

A protective cover... so many advantages

- Extends the service life
- Protects against weather conditions
- Protects against dirt & moisture
- Protects against mold & fungus

The protectors are available for these Silky models:

- The Corner Seat
- The Club Seat
- The Single Seat
- The Long Chair
- The Square Pouf
- The Round Pouf

A good protective cover should protect but at the same time prevent suffocation, otherwise your furniture will go mouldy. The protector has a water-repellent outer layer and a breathable inner layer.

The protective cover is custom-made and completely encloses your Silky. It can be closed with simple velcro fasteners and a zip at the back. The grip at the top makes lifting very easy.



the silky protector



Silky Cushion Azure
with/without fringes
50 x 57 cm - 19.7" x 22.4"



Silky Cushion Azure
with/without fringes
40 x 47 cm - 15.7" x 18.5"



Silky Cushion Azure
30 x 50 cm - 11.8" x 19.7"



Silky Cushion Anthracite
30 x 50 cm - 11.8" x 19.7"



Silky Cushion Eggplant
with/without fringes
50 x 57 cm - 19.7" x 22.4"



Silky Cushion Eggplant
with/without fringes
40 x 47 cm - 15.7" x 18.5"



Silky Cushion Eggplant
30 x 50 cm - 11.8" x 19.7"



Silky Cushion Grey
30 x 50 cm - 11.8" x 19.7"



Silky Cushion Lilac
with/without fringes
50 x 57 cm - 19.7" x 22.4"



Silky Cushion Lilac
with/without fringes
40 x 47 cm - 15.7" x 18.5"



Silky Cushion Lilac
30 x 50 cm - 11.8" x 19.7"



Silky Cushion Terracotta
30 x 50 cm - 11.8" x 19.7"



Silky Cushion Seaglass
with/without fringes
50 x 57 cm - 19.7" x 22.4"



Silky Cushion Seaglass
with/without fringes
40 x 47 cm - 15.7" x 18.5"



Silky Cushion Seaglass
30 x 50 cm - 11.8" x 19.7"



Silky Cushion Gold
30 x 50 cm - 11.8" x 19.7"



Silky Cushion Champagne
with/without fringes
50 x 57 cm - 19.7" x 22.4"



Silky Cushion Champagne
with/without fringes
40 x 47 cm - 15.7" x 18.5"







Silky Cushion Champagne
30 x 50 cm - 11.8" x 19.7"



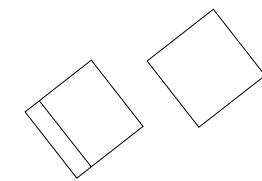
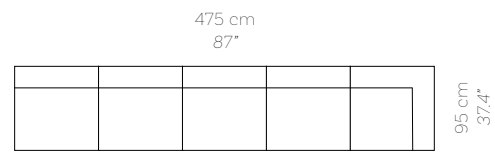



Silky Cushion Beige
30 x 50 cm - 11.8" x 19.7"



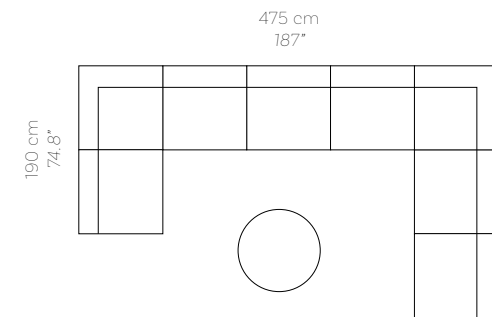

-  5x the single seat
-  1x the corner seat
-  1x the square pouf



-  6x the single seat
-  2x the corner seat
-  1x the round pouf

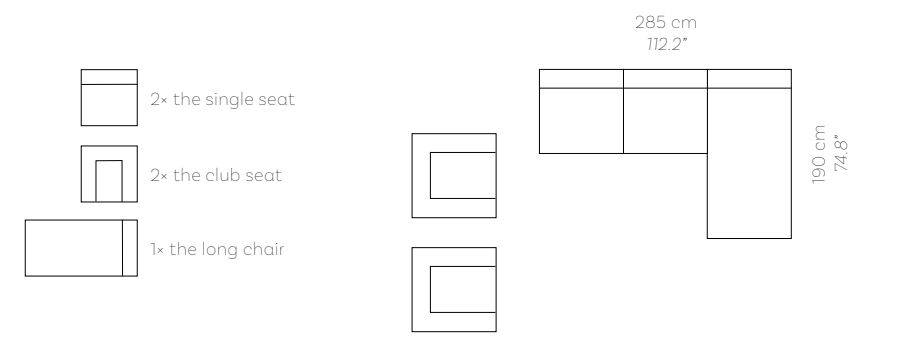
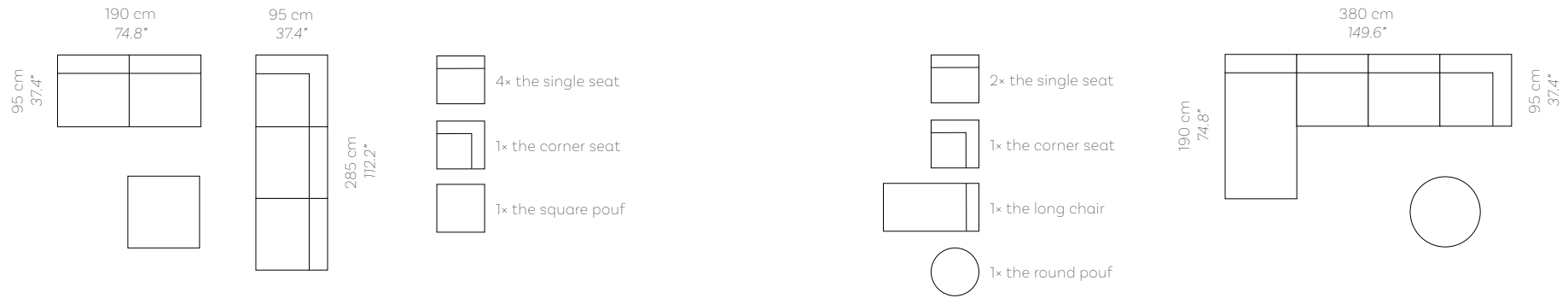



Roof Living Headquarters

Wantestraat 16
8780 Oostrozebeke
www.roof-living.com
info@roof-living.com

@roofliving



The possible differences between the original colours and the captured colours are due to the printing technique.

Roof-Living reserves the right over the photographs and designs made, so it is forbidden to reproduce on any way and/or on any medium or support.

Roof-Living reserves the right to modify, in whole or in part, without prior notice, any information or technical specification of this publication.

All the information that appears in this catalogue in terms of dimensions and capacity are approximate and are susceptible to variations due to improvements in the production process.

Copyright 2025/2026, Roof-Living. All rights reserved

Contact us

